

RODEO 150

QUICK START GUIDE **V1.0**

3th-MAY-2016



Contents

1.0 Get to know your aircraft	2
2.0 Get to know your Remote Controller	3
3.0 Specifications	4
4.0 Attention before flight	4
5.0 Charge the Battery	5
6.0 Prepare the Rodeo 150	5
7.0 Ready for flight	6
7.1 Binding of the Rodeo 150	6
7.2 Motor Unlock / Lock	7
8.0 Operation Instruction	8-10
9.0 End flight	10
10.0 Additional remarks	11
10.1 DEVO F7 Remote Controller Setting	11-12
10.2 DEVO 7 Remote Controller Setting	13-14
10.3 TX5832(FCC)/TX5833(CE) Video transmitting channel selection	15
10.4 Introduction for DEVO-RX716 receiver	15
10.5 Introduction for FCS-Rodeo 150 Main Flight Controller	16
10.6 Brushless ESC and Brushless Motor connection diagram	16
10.7 Introduction for power board	17
11.0 Instructions for GA005 balance charger	18

1.0 Get to know your aircraft

- Modern industrial and modular design, improves the product performance and easy maintenance and upgrades.
- Advanced 5.8ghz live video, for a unforgettable visual FPV experience.
- The Rodeo 150 employ a modern flight control system for acrobatic flight routines such as roll, flip and race courstte moves.

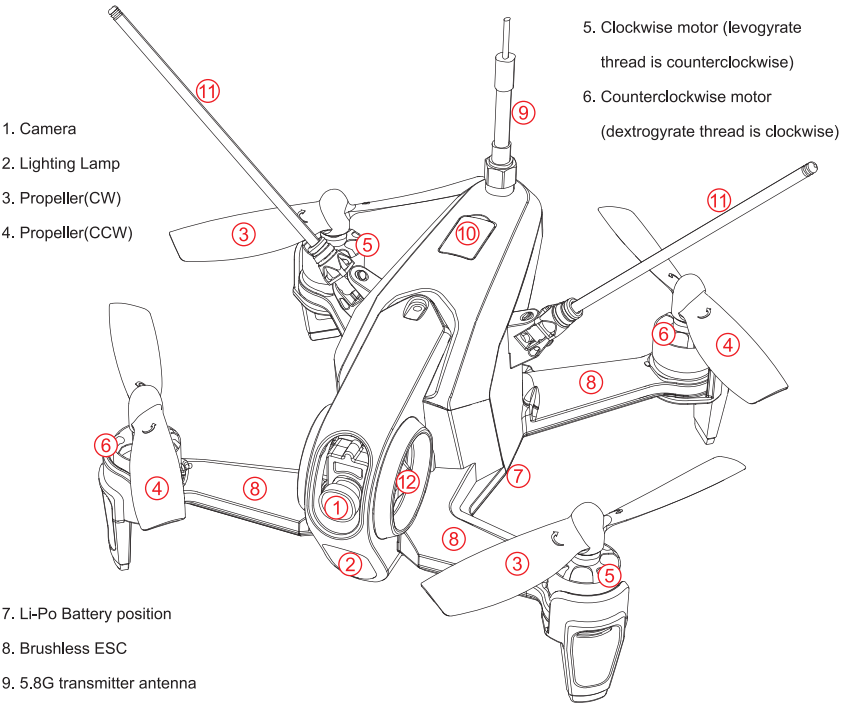

7. Li-Po Battery position
 8. Brushless ESC
 9. 5.8G transmitter antenna
 10. Code switch position
 11. DUAL reciever antennas
 for best performance
 * always extend before flying

12. Red LED light
 13. Main Flight Controller upgrade port
 14. External receiver connection port
 15. 5V power output port
 16. Receiver toggle switch of PPM and SBUS

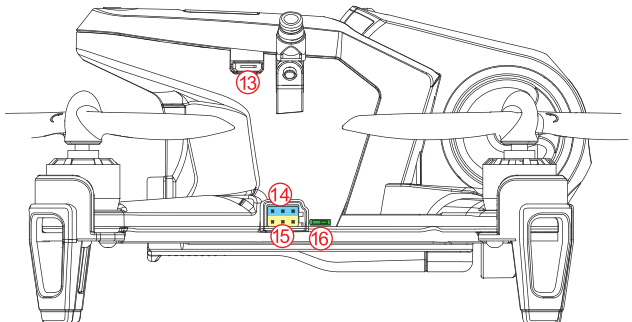

* Please read the manual carefully before taking off to avoid any damage to your personal and property safety.

2.0 Get to know your Remote Controller

The Rodeo 150 feature 3 useful flight modes, STABILIZE / INTERMEDIATE / ADVANCED(RATE) Flight modes are selected by the MIX switch.

* Select the appropriate mode according to your flight skills.



* For your first test flight with a new quad, always start with the STABILIZE mode.

※ STABILIZE Flight mode: the main flight controller system comes with stabilization function, its operation is relatively stable, it can not roll, it is suitable for beginners.

※ INTERMEDIATE flight mode: the main flight controller system comes with partial stabilization function, its operation is relatively flexible, it can roll.

※ ADVANCED Flight Mode: the main flight controller system without stabilization function, its operation is very flexible, it can roll.

MODE 2 (Throttle stick on the left)	Left stick	THRO/RUDD stick
	Right stick	ELEV/AILE stick
	Left trim	THRO trim
	Right trim	ELEV trim
MODE 1 (Throttle stick on the right)	Left stick	ELEV/RUDD stick
	Right stick	THRO/AILE stick
	Left trim	ELEV trim
	Right trim	THRO trim

STABILIZE Flight Mode	INTERMEDIATE Flight Mode	ADVANCED Flight Mode
		
MIX Switch to "0"	MIX Switch to "1"	MIX Switch to "2"

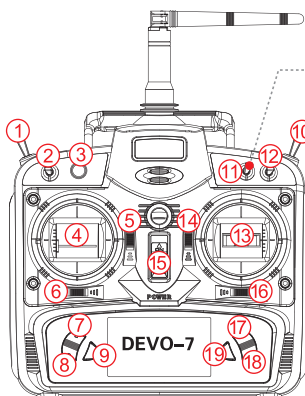
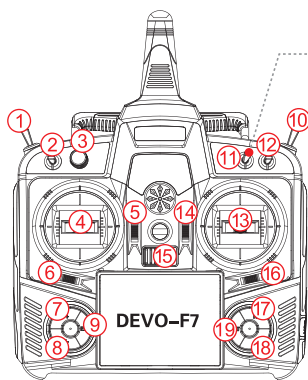

1. HOLD TRN switch
2. GEAR switch
3. AUX2 control
4. Left stick
5. Left trim
6. RUDD trim

7. UP+ key
8. DN- key
9. EXT key
10. FMOD Switch
11. MIX - Flight Mode Switch
12. ELEV/AILE/RUDD D/R Switch

13. Right stick
14. Right trim
15. Power switch
16. AILE trim
17. R+ key
18. L- key
19. ENT key

3.0 Specifications

• Aircraft

Main Rotor Dia.:	96mm
Overall (L x W x H):	137 x 148 x 77mm
Weight:	200g (Battery included)
Remote Controller:	DEVO 7 / DEVO F7
Receiver:	DEVO-RX716
Main Flight Controller:	FCS-Rodeo 150
Transmitter:	TX5832(FCC)/TX5833(CE)
Brushless motor:	WK-WS-17-002(CW/CCW)
Brushless ESC:	Rodeo 150
Battery:	7.4V 850mAh 30C 2S LiPo
Flight Time:	7~8mins
Working Temperature:	-10 C ~ +40 C

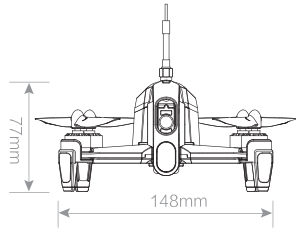
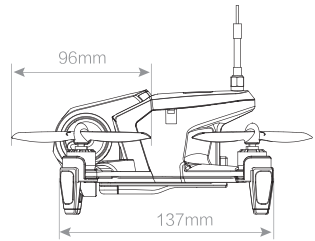

• Camera(600TVL)

Horizontal Resolution:	600TVL
System Committee:	PAL/NTSC
Video Out:	1.0Vp-p/75Ω
Power Input:	DC 5-12V

• TX5832(FCC) / TX5833(CE) transmitter

5.8G wireless image transmission
TX5832(FCC) Bind B section: 4 channels
TX5833(CE) B section: 8 channels
TX5832(FCC) output power ≤200mW
TX5833(CE) output power ≤25mW

4.0 Attention before flight

- 1) The Rodeo 150 mini-quad is recommended for pilots, 14 years or older, with RC hobby experience.
- 2) Only fly the Rodeo 150 in dry weather, with low wind, please do not fly in rain, snow or heavy foggy conditions.
- 3) Always choose large open fields for flying. Check local LAW and ordinances for legal flying areas.
- 4) Always keep at least 10 feet distance to the aircraft when armed, to avoid injury from high-speed propellers on the ground or while flying. Always disarm before handling the aircraft.
- 5) Do not fly close to high-voltage power lines, cellphone towers, or radio towers, as these may disrupt your control signal.
- 6) ALWAYS check local laws BEFORE flying. NEVER fly over crowds, concerts or sports stadiums.

5.0 Charge the Battery

- ① Insert the power adapter(100~240V 50/60HZ), connect the output end to the GA005 balance charger, the balance charger is red LED at this time.
- ② Insert the balanced pin of LiPo battery into GA005.
- ③ During charging, Red LED is continuously flashing. If saturated, Red LED becomes solid green lighting.

⚠ Attention:

- Please refer to Page 18 for details of GA005 balance charger.

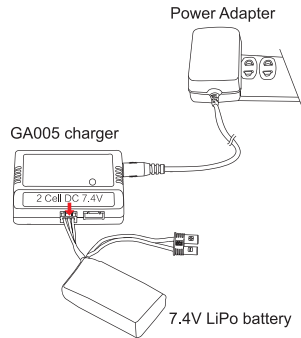

6.0 Prepare the Rodeo 150

Install 5.8G antenna

Firstly install 5.8G antenna onto the transmitter, and tighten with open-end wrench.

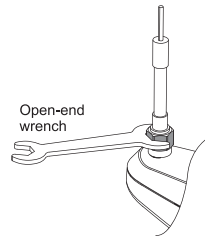

Install propellers

Fix the clockwise propeller(↻) onto the clockwise motor according to the direction of blue arrow, and fix the counterclockwise propeller(↻) onto the counterclockwise motor according to the direction of orange arrow. Tighten the propellers manually and make sure the propeller is installed in proper way and fastened.

⚠ Attention:

- Install prop by hand and tighten by holding the motor with the included wrench.
- You can also use the wrench to help remove broken props in case of a crash.

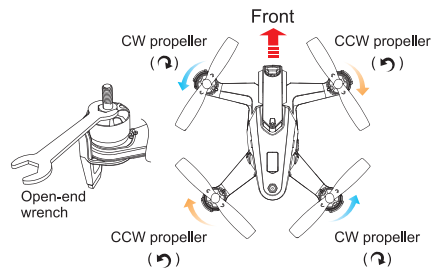

Battery installation

Pull the battery cover button downward, open the battery cover, insert the battery in the aircraft, then close the battery cover

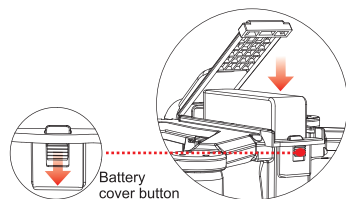

7.0 Ready for flight

⚠ Attention:

- Place the aircraft in a wide open space, with the rear facing you.
(This position is known as "TAIL IN")
- Put all the function switches to the 0 position, put all trims and dials to the Middle position, move the throttle to the lowest position, then turn on the Remote Controller.
- A video receiving equipment is needed(such as DEVO F7, Goggles glasses, etc.) to display an image.
(Setting method please referto P15)
- The Rodeo 150 mini-quad have a low-voltage alarm beeper.
When voltage reach below 7.0 volts the Red LED light will flash quickly and the beeper will sound alarm.
The Rodeo 150 mini-quad is designed for FPV racing, there is no "automatic landing mode".
WARNING: Do not hesitate to land when you hear the alarm.

7.1 Binding of the Rodeo 150

- ① Turn on the Remote Controller. (Make sure all the function switches, all trims/knobs and throttle stick at the lowest position)

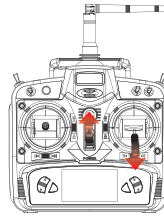

- ② Open the battery cover, connect the aircraft power, then close the battery cover, and put the aircraft on a horizontal position place, the buzzer will send out the voice of "BB". (make sure the positive and negtive connected correctly)

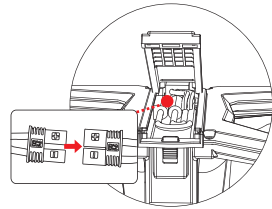

- ③ The code binding will be successful if the red LED light flashes slowly then goes out and the buzzer stops making BB sound. Pls bind the code once again if the buzzer keeps on making BB sound.

💡 Tips:

- Do not move the Rodeo 150 during binding.
- ALWAYS unfold the two reciever anteannas to their correct STRAIGHT UP position before flying.
Do not fly without properly unfolding the antennas.

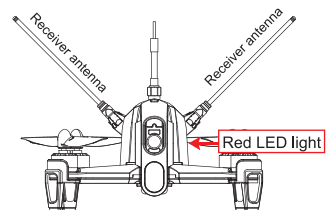

7.2 Motor Unlock / Lock

Motor Unlock

After binding the DEVO 7/ DEVO F7 to the Rodeo 150, Check that all trims are neutral, the throttle stick is ALL the way Down with the display indicating 0% throttle. Check that ALL switches are in the UP position. Gently push the throttle stick down and move the rudder (YAW) stick to the left side and hold for more than 2 seconds. (on mode 2 radios throttle and rudder is the same stick).

You will see the red LED light keeps on and buzzer issues a "B B" sound, indicating that motors are unlocked.

*** After unlocking, motors and propellers will begin to move, for your personal and property safety, please stay away from the aircraft, and then push the throttle stick, the aircraft will take off.**

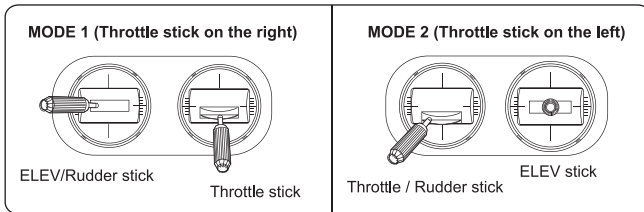

Motor Lock

Lock the motors by moving the throttle stick all the way down and the rudder (YAW) stick all the way to the right. The red LED light turns off and buzzer issues a "B B" sound when the motors are disarmed.

TEST: Push the throttle stick up a little, the motors will not start when locked.

NOTICE: The motors are LOCKED by default after successful binding.

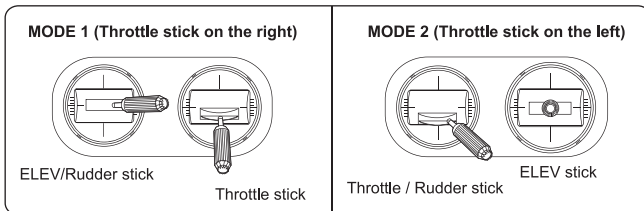

8.0 Operation Instruction

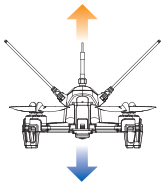
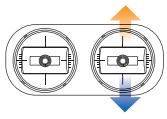
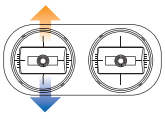
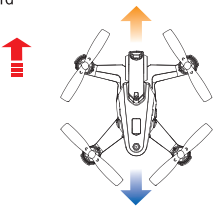
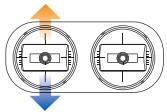
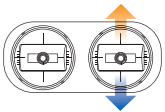
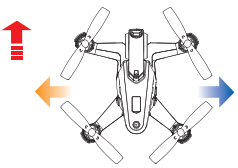
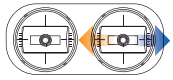
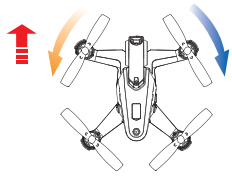
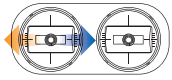
Aircraft posture(← the direction of head)	Remote Controller control instruction	
<p>THROTTLE Up/down The rear toward operator</p> 	 <p>MODE 1 (Throttle stick on the right)</p>	 <p>MODE 2 (Throttle stick on the left)</p>
<p>PITCH Forward/backward</p> 	 <p>MODE 1 (Throttle stick on the right)</p>	 <p>MODE 2 (Throttle stick on the left)</p>
<p>ROLL (lean) Left / right</p> 	 <p>MODE 1 / MODE 2</p>	
<p>YAW (turn) Left / right</p> 	 <p>MODE 1 / MODE 2</p>	

The aircraft roll forward

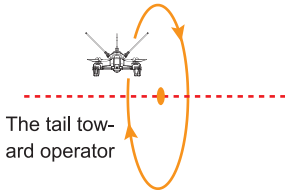

The aircraft roll backward

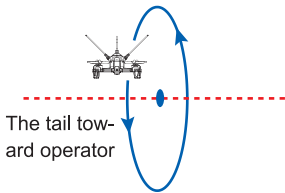

The aircraft roll left

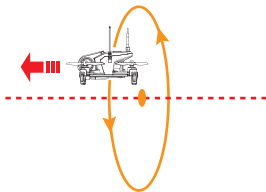

The aircraft roll right

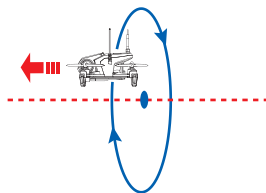

FLIP & ROLL'S

Are only available in the intermediate & Advanced flight mode.
Set MIX switch to position 1 or 2, to select the appropriate flight mode.

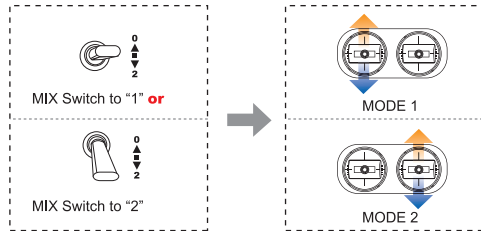

Attention:

- 1) Always select large open spaces with soft ground for flying.
- 2) Rolls and flips are best suited for experienced pilots.
- 3) Match throttle power to the flight to manage altitude.

FLIP & ROLL'S

Are only available in the intermediate & Advanced flight mode.
Set MIX switch to position 1 or 2, to select the appropriate flight mode.

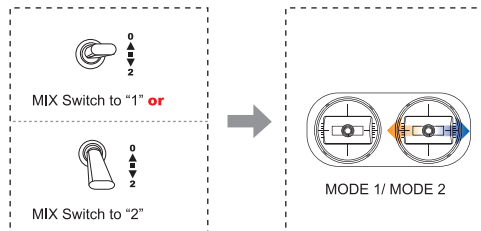

Attention:

- 1) Always select large open spaces with soft ground for flying.
- 2) Rolls and flips are best suited for experienced pilots.
- 3) Match throttle power to the flight to manage altitude.

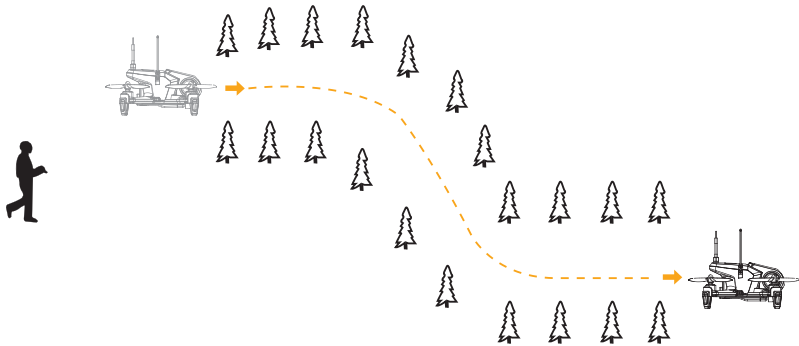
DERAM Baron AKA Proximity FPV obstacle flying**Attention:**

- 1) Dream Baron is more suitable for experienced pilots, highspeed obstacle avoidance flights require advanced skills.
 - 2) Recommended FPV range 300m depending on environment.
 - 3) Avoid flying over people, animals, do not fly over crowds, concerts or sports stadiums. Avoid flying close to powerlines and cellphone towers as these may crash you. Visit walkera.com for more suggestions and for WALKERA racing gates.
-

9.0 End flight

- ① Land the aircraft, disarm(lock) the aircraft.
- ② First Power off the aircraft by unplugging the battery, then turn off the radio.
- ③ Finally, remove the battery from the aircraft.

10.0 Additional remarks

10.1 DEVO F7 Remote Controller Setting

Boot Screen(Main interface)

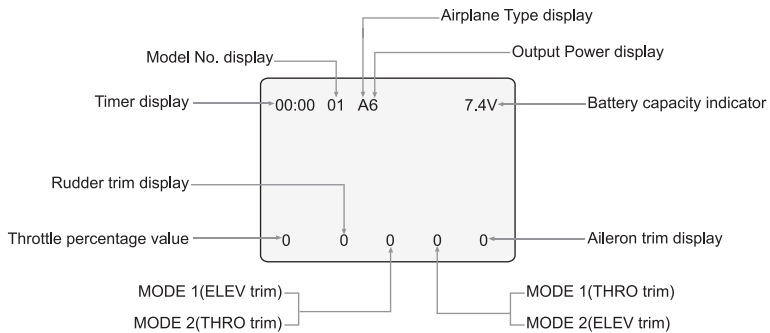

Model Select

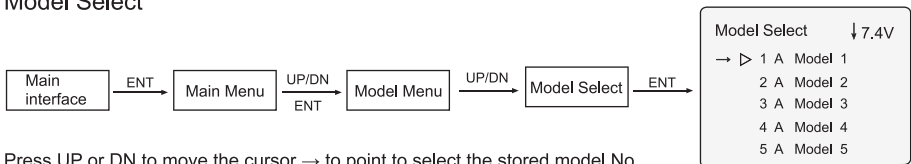

Press UP or DN to move the cursor → to point to select the stored model No.

For example "Model 1", press ENT to confirm and then press EXT to return to Model Menu.

Model Name

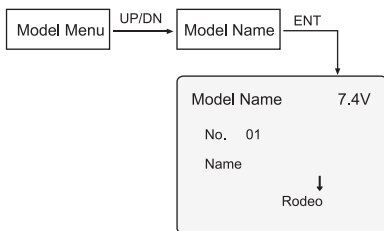

Press UP or DN to move the cursor → to point to select the character and figure which need to be changed, press R or L button to change the character and figure, name model as Rodeo. Press ENT to confirm and then press EXT to return to Model Menu.

Type Select

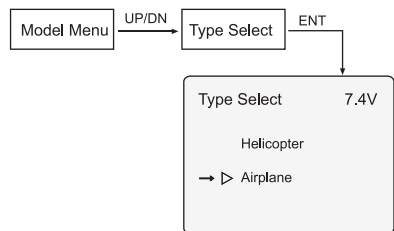

Press UP or DN to move the cursor → to point to Airplane option. Press ENT to confirm and then press EXT to return to Model Menu.

Wing Type

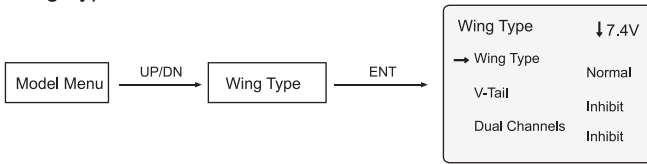

Press UP or DN to move the cursor → to point to Wing Type option, press R or L to select "Normal".
Press ENT to confirm and then press EXT to return to Model Menu.

Device Output

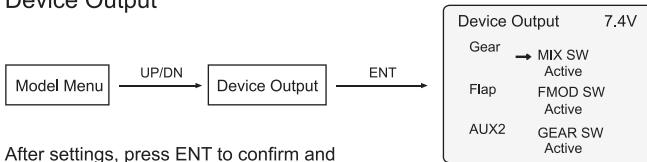

After settings, press ENT to confirm and then press EXT to return to Main Menu.

Reverse Switch



Press R or L to select Normal.
After settings, press ENT to confirm and then press EXT to return to Main Menu.

Reverse Switch	↓ 7.4V
→ Elevator	Normal
Aileron	Normal
Throttle	Normal
Rudder	Normal
Gear	Normal

Reverse Switch	↑ 7.4V
→ Flap	Normal
AUX2	Normal

Video Select

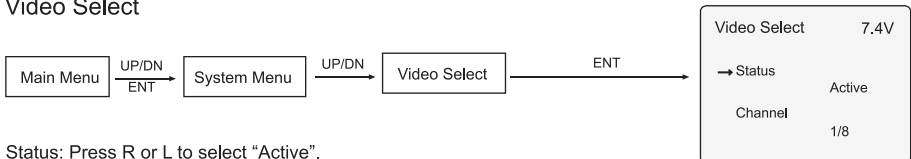

Status: Press R or L to select "Active".

Channel: Press R or L to select suitable receiving video channel corresponding to the TX5832(FCC)/TX5833(CE).

After settings, press ENT to confirm and then press EXT to return to Main interface.

10.2 DEVO 7 Remote Controller Setting

Boot Screen(Main interface)

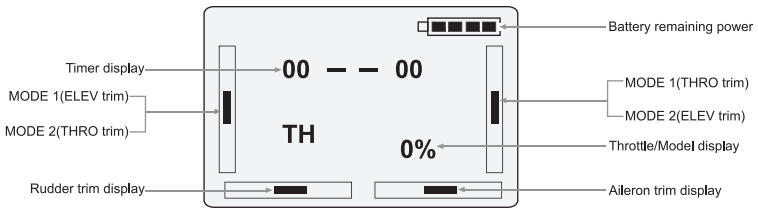

SELEC

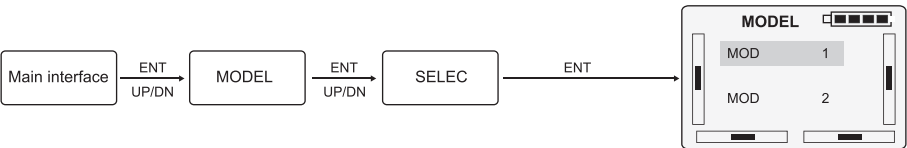

Press UP or DN to select "MOD 1", press ENT to confirm and then press EXT to return to MODEL.

NAME

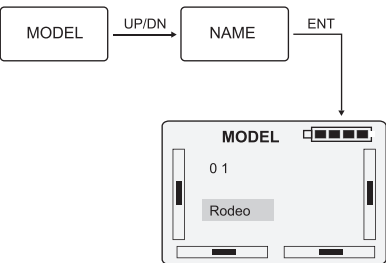

Press R or L button to change the character and figure, named model as Rodeo. Press ENT to confirm and then press EXT to return to MODEL.

TYPE

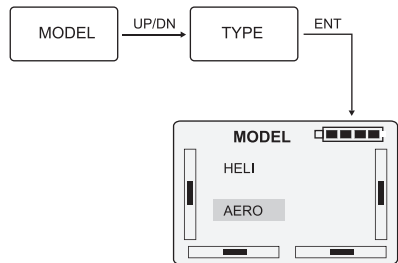

Press UP or DN to select AERO, Press ENT to confirm and then press EXT to return to MODEL.

WING

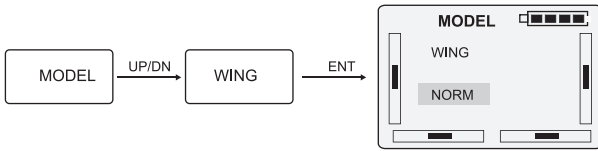

Press R or L to select NORM, Press ENT to confirm and then press EXT to return to MODEL.

OUTPUT

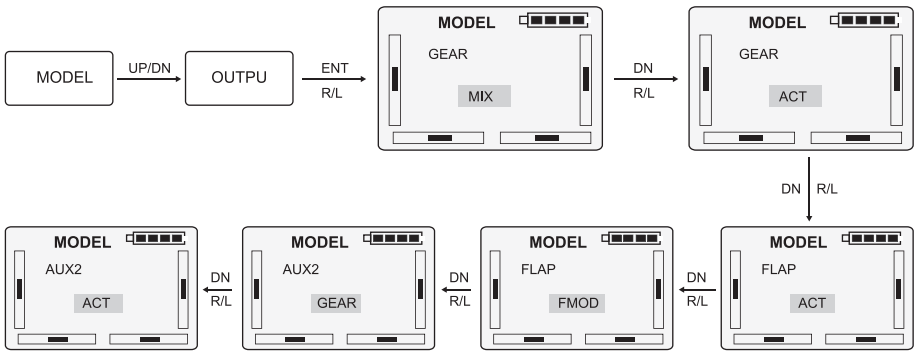

After setup, press ENT to confirm and then press EXT to return to Main interface.

REVSW

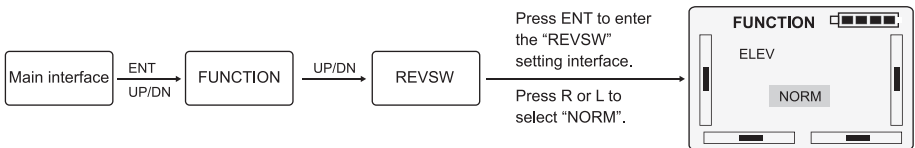

ELEV	AILE	THRO	RUDD	GEAR	FLAP	AUX2
NORM	NORM	NORM	NORM	NORM	NORM	NORM

After settings, press ENT to confirm and then press EXT to return to Main interface.

10.3 TX5832(FCC)/TX5833(CE) Video transmitting channel selection

Port introduction

1. Camera connect Port: used to connect camera
2. Power connect port: used to connect power
3. Position of 5.8G antenna
4. Code Switch

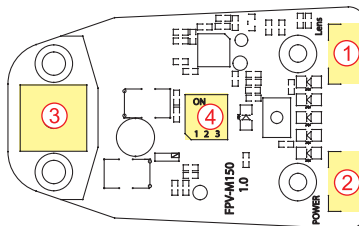

Video transmitting channel selection

There are 8 channels available, choose the best channel based on the image quality on your screen. Select the channel by adjusting the dip-switches on the video-transmitter according to the diagram.

Channel	1	2	3	4	5	6	7	8
Frequency	5866MHz	5847MHz	5828MHz	5809MHz	5790MHz	5771MHz	5752MHz	5733MHz
Code position (on/off)								

⚠ Attention:

- Only 2, 4, 6, 8 channels are available for the TX5832(FCC) transmitter.
- Video transmitter channel must match the receiver channel.

10.4 Introduction for DEVO-RX716 receiver

Port introduction

1. Power connect port: used to connect power
2. Fixed ID clear button

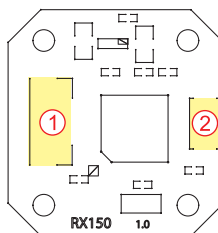

Fixed ID Code - clearing method

If you want to clear the fixed-ID, after having set a fixed-ID from the remote controller, Press the CLEAN button and power the Rodeo 150, when successful, the receivers RED LED will blink slowly to indicate the fixed-ID have been cleaned. Make sure you set the Remote Controllers fixed-ID setting to OFF. (to set a fixed-ID, please refer to the remote controller manual)

10.5 Introduction for FCS-Rodeo 150 Main Flight Controller

Flexible flat cable connection

The metal surface of flexible flat cable plug should be inserted upward to main controller port properly.



The metal surface of flexible flat cable plug should be inserted downward to power board port properly.

Port introduction

- 1. 4 pins port: Not used
- 2. 6 pins port: Not used
- 3. USB port: used for upgrading
- 4. Connection port: used to connect flexible flat cable

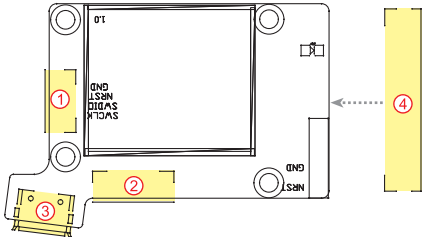

Upgrading

Please upgrade online via Walkera official website

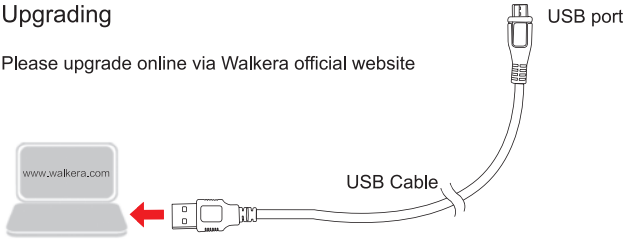

10.6 Brushless ESC and Brushless Motor connection diagram

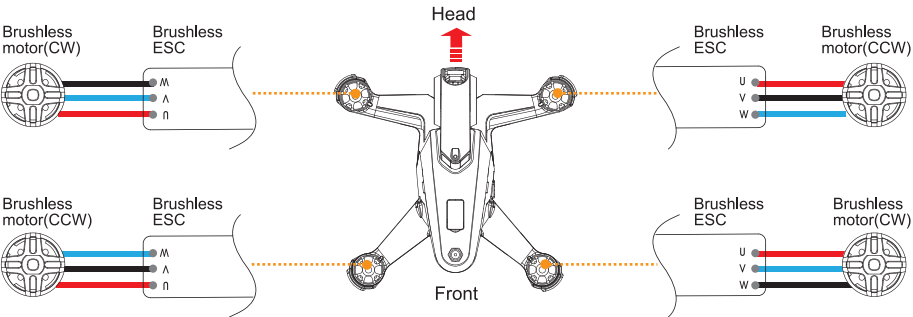

10.7 Introduction for power board

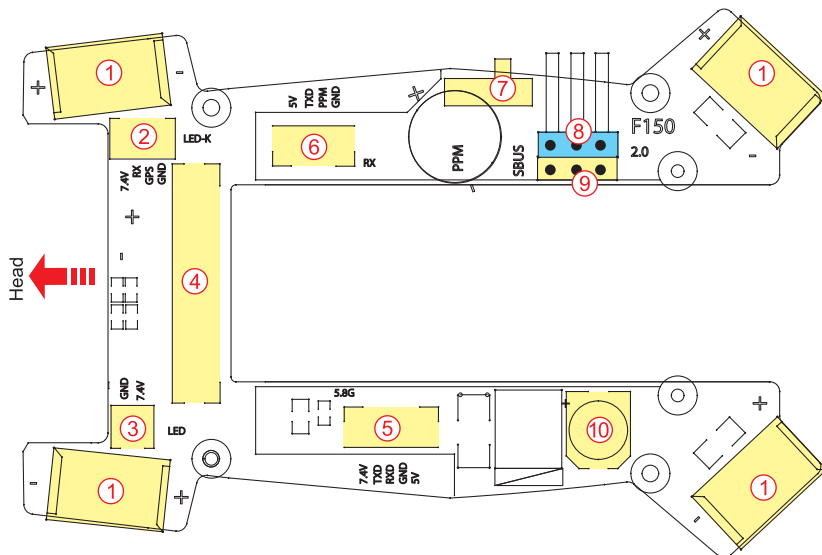

- | | |
|--|--|
| <ul style="list-style-type: none"> 1. Brushless ECS connect position 2. Signal light connection port 3. Lighting Lamp connect port 4. Main controller Flexible flat cable connect port 5. 5.8G transmitter connect port 6. Receiver connect port | <ul style="list-style-type: none"> 7. Receiver toggle switch of PPM and SBUS 8. 5V power output port 9. External receiver connection port 10. Buzzer: a kind of alarm device which will alarm automatically when the signal between the aircraft and remote controller lost suddenly or battery voltage lower than 7.0V. |
|--|--|

11.0 Instructions for GA005 balance charger

Parameters of GA005 balance charger

Input voltage	Input current	Output current	Dimension	Weight
DC15-18V	1000mA	≤800mA	62.5 x 47 x 20.8mm	46g

Features of GA005 balance charger

- 1) GA005 utilizes microcomputer chips to monitor and control over the whole charging process in a balanced way with LED indicator to display the charging status at real time.
- 2) Connects to an input power supply (DC 15-18V 1000 mA).
- 3) GA005 is suitable for 7.4V/ 11.1V Li-ion or Li-polymer battery pack.
- 4) GA005 can detect Li-Po battery automatically. GA005 will automatically charge when it finds the voltage of single cell battery is excessively low. At the same time LED displays as charging status (flash in red).
Control single cell battery voltage at the range of $4.2 \pm 0.05V$ to ensure the maximum voltage difference of single cell in the battery is less than 50 mV.

Instruction of GA005 balance charger

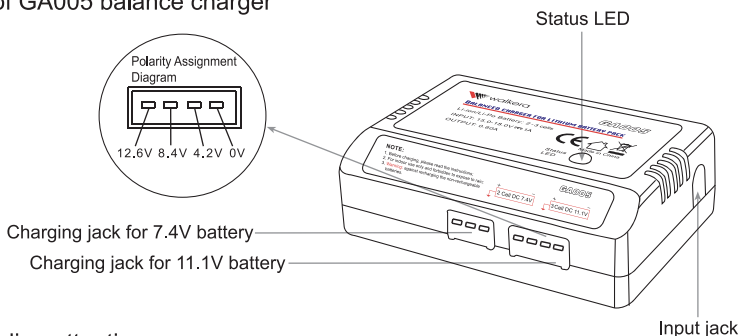

Matters needing attention

- 1) GA005 is only used to charging a 2S or 3S Li-ion or Li-polymer battery. It is forbidden to simultaneously charge two or more sets of batteries. Either the charger or battery may be damaged.
- 2) During charging, GA005 should be put in dry and ventilated place and be far away from heat sources and inflammable and explosive substances.
- 3) When charging, the battery should be removed from your helicopter. Never leave the charger unsupervised during the process of charging in order to avoid risk of accidents.
- 4) Never immediately charge your battery as soon as the flight is finished, or when its temperature doesn't cool down. Otherwise the battery will take a risk in swelling, even a fire.
- 5) Ensure the correctness of polarity before connecting the battery to charger.
- 6) Avoid drop and violence during the process of charging. Drop and violence will result in internal short circuit of the battery.
- 7) For the sake of safety, please use original charging equipment (wall adapter + GA005 balance charger) and battery. Please change new one in time when the old battery pack is becoming swollen due to long time usage.
- 8) If it is retained in the charger for a long time after saturated, the battery may automatically discharge.
When the charger detects that the voltage of individual cells is lower than the rated voltage, it will re-charge until saturated. Frequently charging and discharging will shorten the lifetime of your battery.



 Tel: 400-9318-878

User manual is subject to change without prior notice.

Please go to Walkera official website to get the latest version.

