

# FURIOUS 215

QUICK START GUIDE **V1.0**

Mar. 7th, 2017

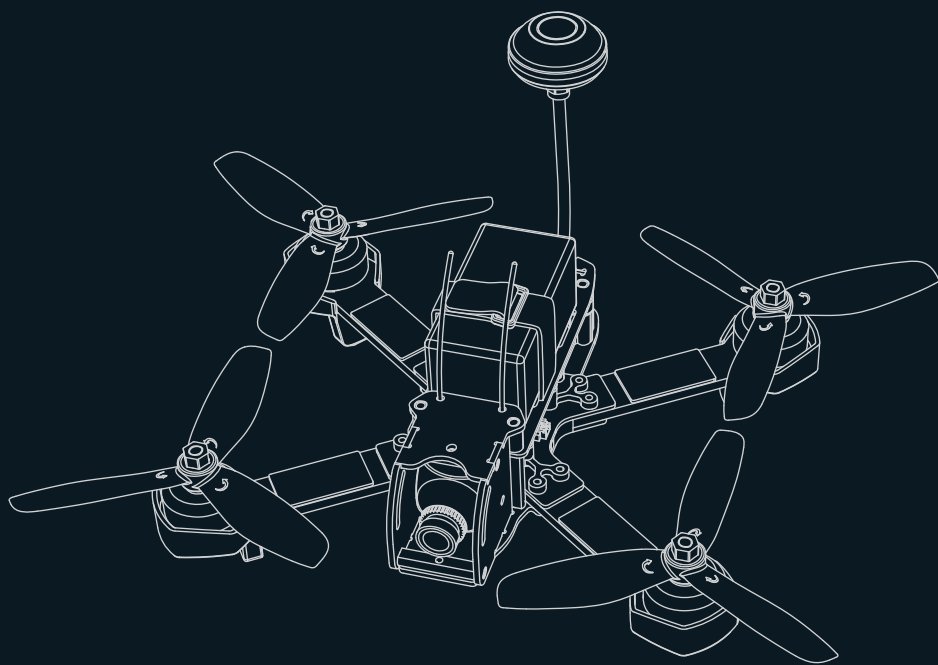

# Contents

1.0 Knowing your aircraft	3
2.0 Knowing your remote controller	4
3.0 Specifications	5
4.0 Notes for flight	6
5.0 GA009 charging	6
6.0 Prepare remote controller	6
7.0 Prepare aircraft	7
8.0 Ready for flight	8
8.1 Aircraft code-matching	8
8.2 Motor Unlock / Lock	9
9.0 Flight control	10-11
10.0 End of flight	11
11.0 Additional instruction	12
11.1 DEVO 7 Remote Controller Settings	12-13
11.2 OSD information	14
11.3 TX5838(FCC)/TX5839(CE) Transmitter Channel Selection	14
11.4 DEVO-RX721 receiver introduction	14
11.5 FCS-F215 flight controller introduction	15
11.6 Connection diagram of brushless ESC & brushless motor	15

## 1.0 Knowing your aircraft

- With its body structure made of carbon fiber composite, it features ultra-high tenacity and good resistance to impact.
- Brand-new industrial and modular designs are employed to improve its expandability, ease of installation/maintenance and expandability.
- Equipped with 5.8G real-time video transmission system and OSD system, it brings about a different visual effect.
- It is capable of presenting forward/backward, right/left rollover and racing as well as other aerobatic flight experience.

1. Camera
2. Clockwise propeller
3. Counterclockwise propeller
4. Brushless Motor
5. Brushless ESC
6. Decorative lamp port
7. Landing gear

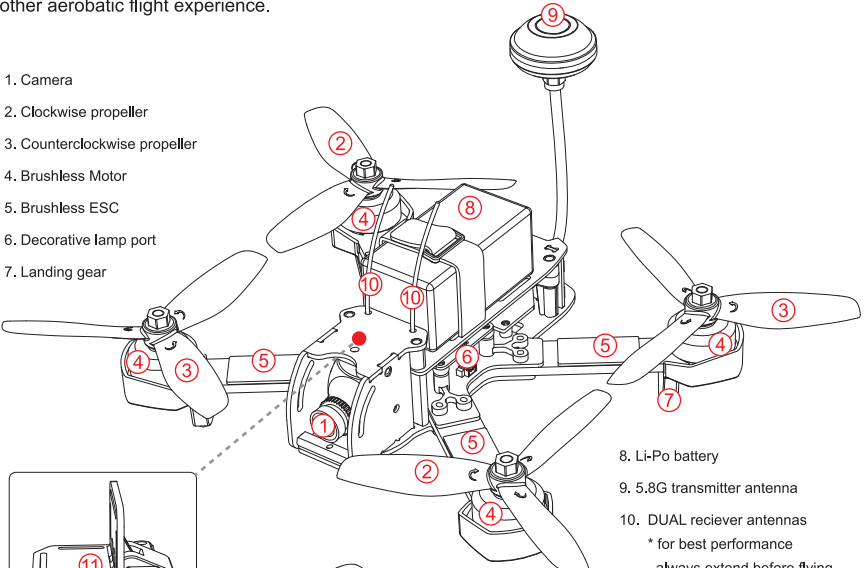

8. Li-Po battery
9. 5.8G transmitter antenna
10. DUAL reciever antennas  
\* for best performance  
always extend before flying
11. Sports camera mount  
\* When sports camera is configured,  
camera mount needs to be installed.

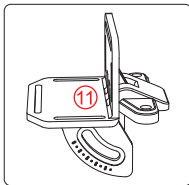

12. Upgrade port
13. Power port
14. Status indicator

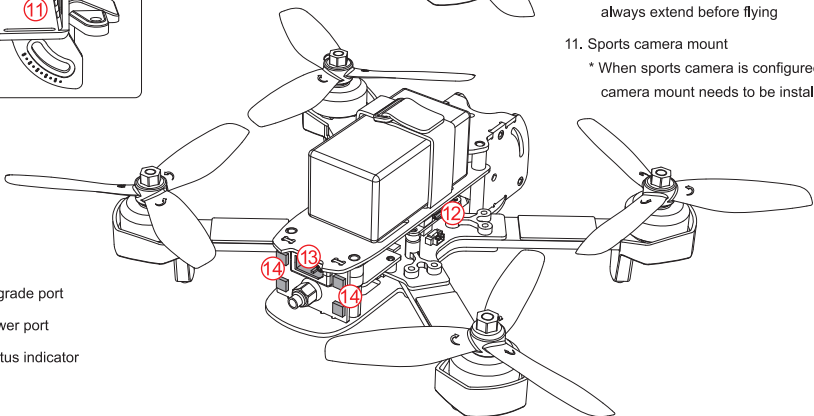

\* 1) Prior to using Furious 215, you are kindly requested to visit Walkera official website ([www.walkera.com](http://www.walkera.com)) for watching teaching video and carefully read Quick Start Guide, so as to avoid property loss and personal injuries caused by misoperation.

2) Never use non-walkera batteries. walkera takes no responsibility for any damage caused by non-walkera batteries.

## 2.0 Knowing your remote controller

DEVO 7 remote controller is equipped with functional switches of primary flight / mid-level flight / high-level flight modes, which are easy to operate. (You may select the flight mode suitable with your flying skill)

- ※ Primary flight mode: the flight control system provided with autostability function can achieve stable operation but not rollover, which is suitable for beginners.
- ※ Mid-level flight mode: the flight control system provided with partial autostability function can achieve relatively flexible operation and rollover.
- ※ High-level flight mode: the flight control system provided with the autostability function can achieve highly flexible operation and rollover.

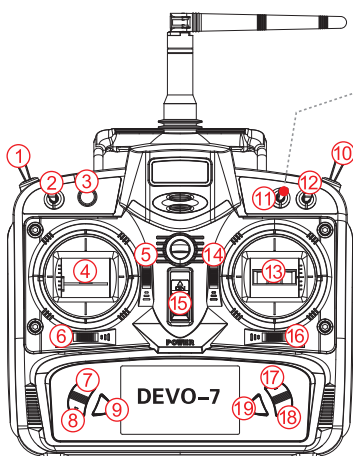

Primary flight mode	Mid-level flight mode	High-level flight mode
MIX switch toggles to "0"	MIX switch toggles to "1"	MIX switch toggles to "2"

- |  |  |
|--|--|
| <ol style="list-style-type: none"> <li>1. HOLD TRN switch</li> <li>2. GEAR switch</li> <li>3. AUX2 knob</li> <li>4. Left rocker</li> <li>5. Left trim</li> <li>6. RUDD trim</li> <li>7. UP+ key</li> <li>8. DN- key</li> <li>9. EXT key</li> <li>10. FMD Switch: to control motor idles<br/>(Location "0" closed, location "1 or 2" open, turn off airmode before landing.)</li> </ol> | <ol style="list-style-type: none"> <li>11. MIX switch: control mode switch</li> <li>12. ELEV/AILE/RUDD D/R Switch</li> <li>13. Right rocker</li> <li>14. Right trim</li> <li>15. Power switch</li> <li>16. AILE trim</li> <li>17. R+ key</li> <li>18. L- key</li> <li>19. ENT key</li> </ol> |
|--|--|

Take "left-hand throttle (MODE 2)" as an example. The left rocker controls the aircraft's altitude and heading, while the right rocker controls its forward, backward, left and right movements.

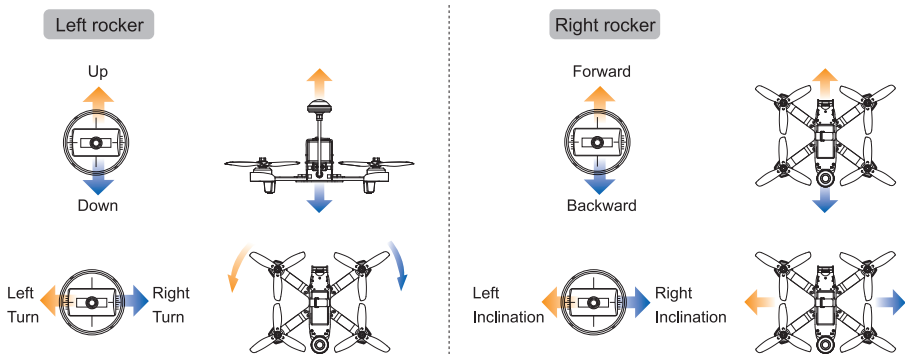

\* 1) Left-hand throttle (MODE 2): left rocker—THRO/RUDD, right rocker—ELEV/AILE  
 2) Right-hand throttle (MODE 1): left rocker—ELEV/RUDD, right rocker—THRO/AILE

## 3.0 Specifications

### • Aircraft

Main Rotor Dia.:	127mm
Overall (L x W x H):	168 x 209x 71.5mm
Weight:	375g (excl. battery)
Remote Controller:	DEVO 7
Receiver:	DEVO-RX721
Flight Controller:	FCS-215
5.8G transmitter:	TX5838(FCC)/TX5839(CE)
Brushless Motor:	WK-WS-28-017(2500KV)
Brushless ESC:	Furious 215 ESC
Battery:	14.8V 1300mAh 60C 4S LiPo
Flight Time:	8~9mins
Working temperature:	-10 C ~ +40 C

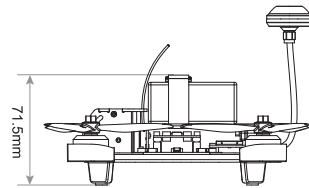
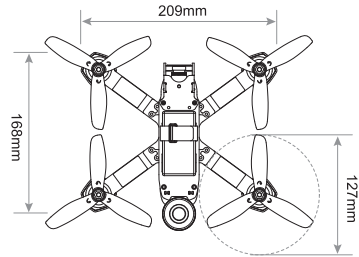

### • Camera

Lens:	2.5mm
Image Sensor:	1/3" Sony SUPER HAD II CCD
Horizontal Resolution:	600TVL
Integrated MIC:	Yes
WDR:	D-WDR
DNR:	2DNR
Day/Night:	Color/Auto/B&w
Power:	DC 5-17V

### • DEVO 7 remote controller

Frequency:	2.4GHz DSSS
Output power:	≤100mW
Current consumption:	≤230mA(100mW)
Power Supply:	5# Battery 8x1.5V or NiMH 8x1.2V 1600-2000mAh
Output Pulse:	1000-2000mS(1500Ms Neutral)

### • TX5838(FCC) / TX5839(CE) transmitter

5.8G wireless image transmission
TX5838 B-band 8-channel selection
TX5839 B-band 8-channel selection
TX5838 output powers≤200mW
TX5839 output powers≤25mW

## 4.0 Notes for flight

- 1) It is intended for pilots aged 14 or above with model hobby experience.
  - 2) Only fly it in dry weather with low wind, please do not fly in rain, snow or heavy foggy conditions.
  - 3) An open field lawfully permitted must be selected for flying in line with your mental condition and flying skill. +++++
  - 4) Always keep a certain distance from aircraft and keep it from high-speed rotating parts, such as propellers or brushless motors.
  - 5) Do not fly around high-voltage power lines, cellphone basestation or radio towers, as they are likely to interrupt your communication.
  - 6) Always check local laws before flying, never fly an illegal flight.
- 

## 5.0 GA009 charging

- ① Power adapter is connected to mains power (100~240V 50/60HZ), When its output terminal is connected to A009 charger, the charger's green LED light flashes.
- ② Plug the charging terminal of battery into GA009 charger.
- ③ Red LED light remains on during battery charging, red and green LED lights flash alternatively when charging is to complete, and green LED light remains on when charging is completed.



Attention:

- Yellow LED light flashes when a fault occurs in charger or battery, please stop charging.

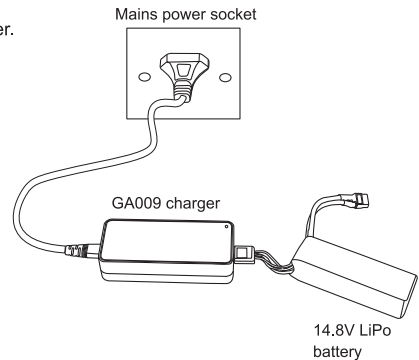

## 6.0 Prepare remote controller

Open battery cover, take out battery case, care must be taken to positive and negative electrodes when 8 pieces of battery #5 or NIMH battery with the same size are inserted.

**Warning: No battery electrodes wrongly matched is permissible. When the plug of battery case is inserted into the power socket of the remote controller, battery case must be inserted with dead end corresponding to dead end.**

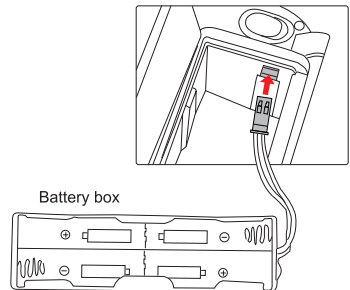

## 7.0 Prepare aircraft

### Install 5.8G transmitter antenna

Antenna installed on transmitter and tightened with a spanner.

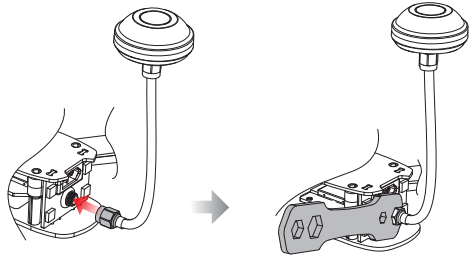

### Install propellers

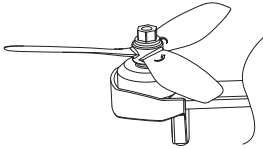

Install the CW /CCW propellers on brushless motors and fastened with locknut.

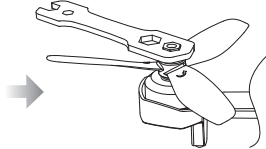

Tightened with spanner, make sure propellers correctly installed and secure.

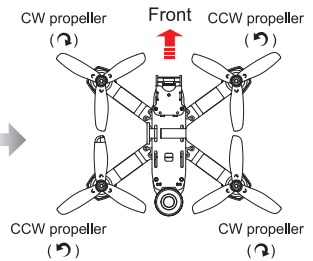

Design Sketch

### Install battery

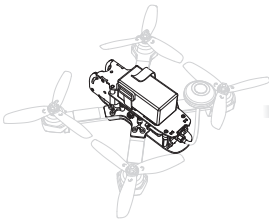

Use velcro to apply battery to aircraft.

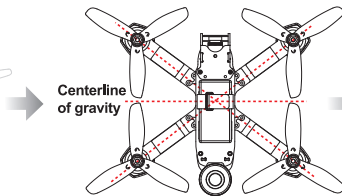

Adjust aircraft's center of gravity, parallel its head and tail.



Fasten battery using sticking band.

## 8.0 Ready for flight



Attention:

- Place aircraft at an open outdoor field, and the user faces its tail.
- Toggle all function switches on remote controller to "0", all tuners/knobs at the midpoint, and throttle rocker at lowest location.
- Images and OSD information can be displayed only when video a receiving device (such as Google glasses) is equipped. (See also page 14 for more information about settings)
- Furious 215 is provided with low-voltage alarm, without low-voltage protection: Red status indicator light quickly flashes and buzzer alarms when battery voltage is under 14.4V. It is urgent to land aircraft as soon as possible to avoid crash.

### 8.1 Aircraft code-matching

- ① Power on remote controller (make sure all function switches are at the position "0", all tuners/knobs at the midpoint, and throttle rocker at lowest location.)

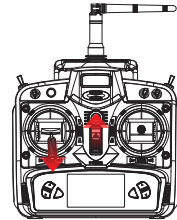

- ② Place aircraft still on a horizontal surface, **connect power supply to aircraft as per diagram**, buzzer will beep. (Make sure positive and negative electrodes are correctly connected)

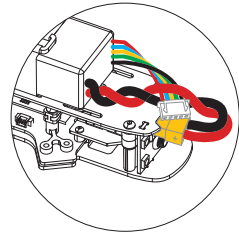

- ③ When blue status indicator lights remain on and buzzer stops beeping, the code-matching process is successful. Always beeping means failure of code matching, please restart code matching.



Warm prompt:

- Never move aircraft during code matching
- Prior to flying, please erect receiver's antenna to increase communication distance.

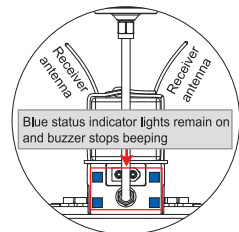



## 8.2 Motor Unlock / Lock

### Motor Unlock

After binding the DEVO 7 to the Furious 215, Check that all trims are neutral, the throttle rocker is ALL the way down with the display indicating 0% throttle. Check that ALL switches are in the UP position.

Gently push the throttle rocker down and move the rudder (YAW) rocker to the left side and hold for more than 2 seconds. (on mode 2 remote controller throttle and rudder is the same rocker).

You will see **the red status indicator lights remain on and buzzer issues a "B B" sound**, indicating that motors are unlocked.

Be very careful at this point, as pushing the throttle up will start the motors.

You can test by pushing the stick up a little, the motors should start.

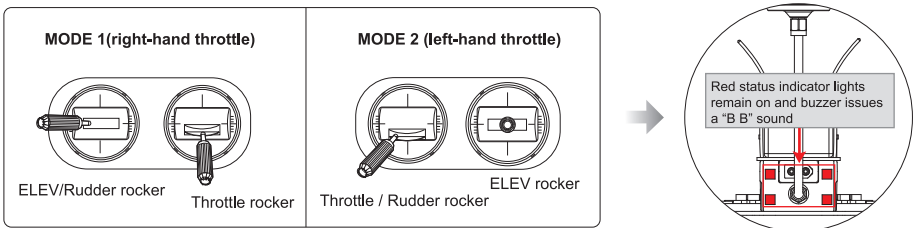

### Motor Lock

Lock the motors by moving the throttle rocker all the way down and the rudder (YAW) rocker all the way to the right.

**You will see the blue status indicator lights remain on and buzzer issues a "B B" sound** when the motors are disarmed.

**TEST:** Push the throttle rocker up a little, the motors will not start when locked.

**NOTICE:** The motors are LOCKED by default after successful binding.

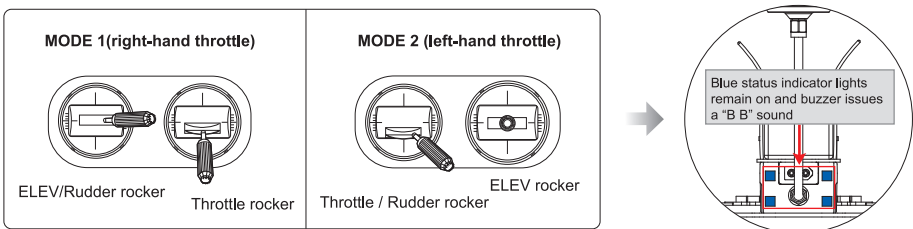

## 9.0 Flight control

Unlock motor before taking off, and manually take off by slowly pushing upward throttle rocker.

### The aircraft forward rollover

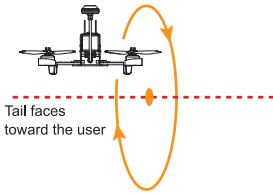

### Aircraft backward rollover

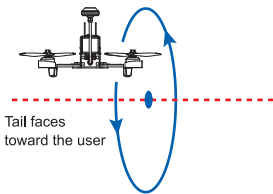

### Aircraft leftward rollover

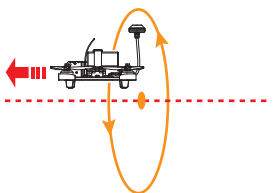

### Aircraft rightward rollover

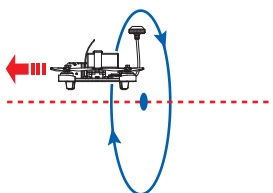

Make sure MIX switch is at the positions "1" or "2", mid-level flight mode or high-level flight mode.

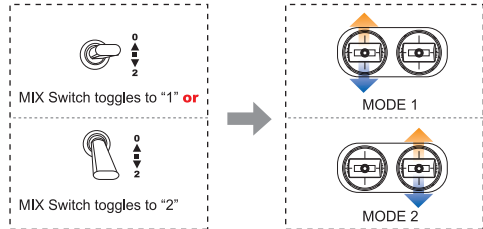

Attention:

- 1) Select a wide-open space with soft ground for flying.
- 2) Rollover flight is fit for experienced remote controller pilots.
- 3) Sufficient flight altitude is required to fly aircraft, and it is required to exercise operation of throttle rocker during rolling.

Make sure MIX switch is at the positions "1" or "2", mid-level flight mode or high-level flight mode.

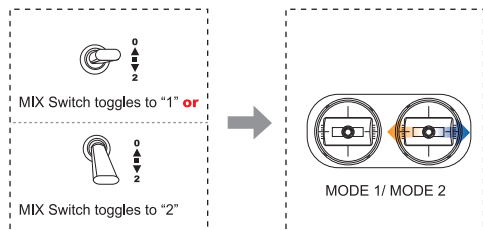

Attention:

- 1) Select a wide-open space with soft ground for flying.
- 2) Rollover flight is fit for experienced remote controller pilots.
- 3) Sufficient flight altitude is required to fly aircraft, and it is required to exercise operation of throttle rocker during rolling.

## Racing Flight

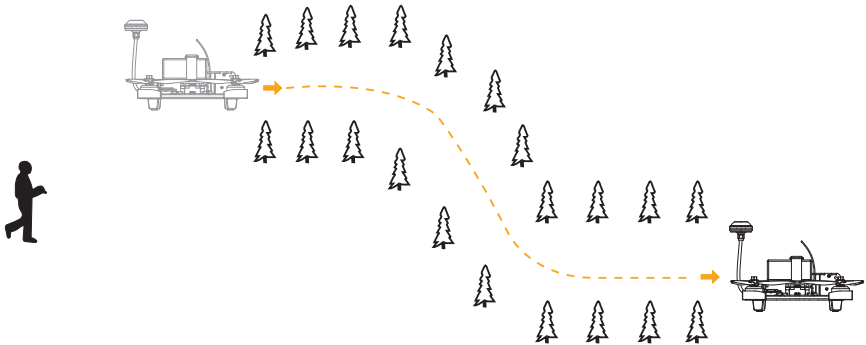

### Attention:

- 1) Racing is fit for experienced remote control pilots
  - 2) During racing, flight must be controlled within 300 meters of video receiving range (actual range depends on flying environment and weather condition).
  - 3) When racing, be sure to keep away from crowds, animals and high-voltage power lines.
- 

## 10.0 End of flight

- ① Manual landing (slowly pull down throttle rocker, until aircraft lands, and then lock motor).
- ② Disconnect power supply for aircraft before switch off power supply for remote controller.

## 11.0 Additional instruction

### 11.1 DEVO 7 Remote Controller Settings

Startup picture(Main interface)

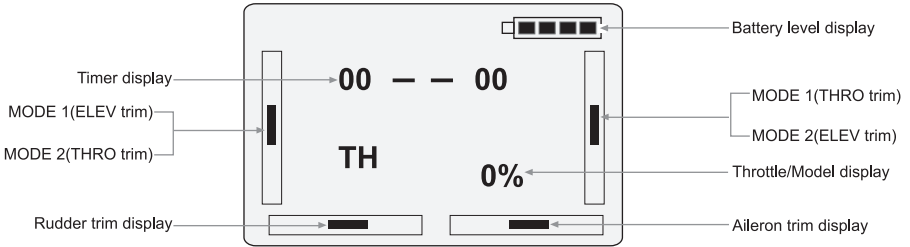

#### Model select (SELEC)

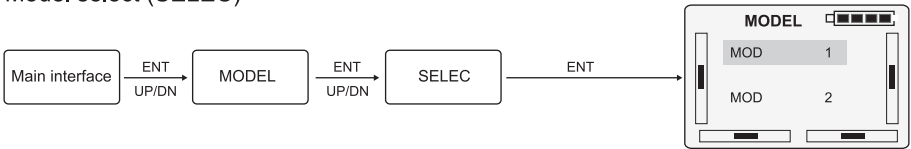

Press UP or DN key to select "MOD 1", and press the key ENT to confirm and press EXT to return back to Model Menu (MODEL).

#### Model Name (NAME)

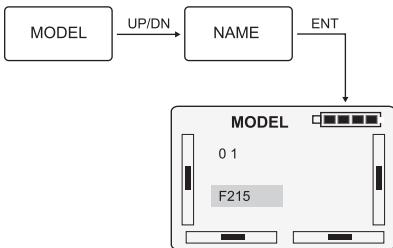

Press R or L to change characters and digits, name the model as "F215", and press ENT to confirm and press the key EXT to return back to Model Menu (MODEL).

#### Model Type (TYPE)

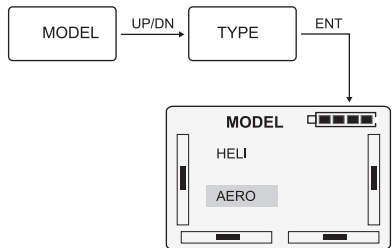

Press UP or DN to select "AERO", and press the key ENT to confirm and press EXT to return back to Model Menu (MODEL).

### Wing Type (WING)

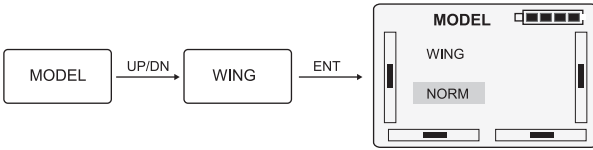

Press key R or L to select "NORM", and press key ENT to confirm and press the key EXT to return back to Model menu (MODEL).

### Device Output (OUTPUT)

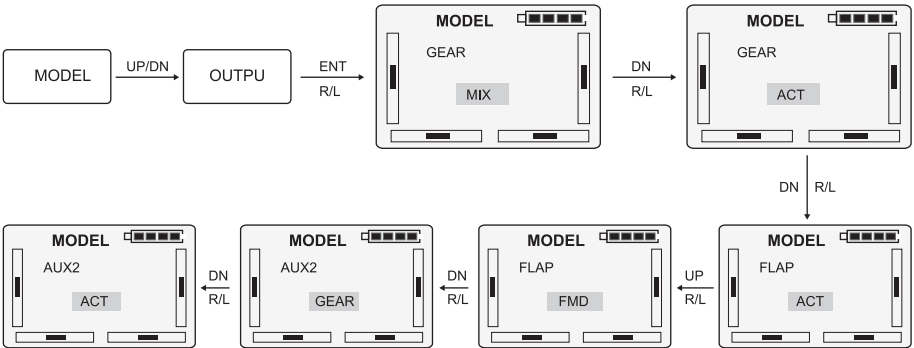

After settings, press ENT to confirm and press EXT to return back to "Main Interface".

### Reverse Settings (REVSW)

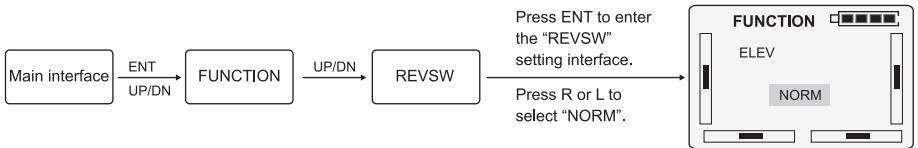

ELEV	AILE	THRO	RUDD	GEAR	FLAP	AUX2
NORM	NORM	NORM	NORM	NORM	NORM	NORM

After settings, press ENT to confirm and press EXT to return back to Main interface.

### 11.2 OSD information

**Video receiver is needed to display OSD information. (Such as Goggles glasses)**



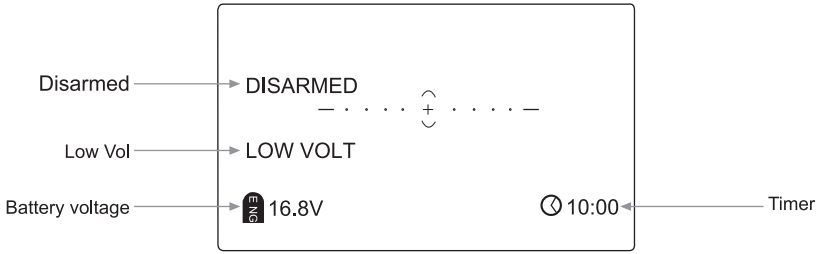





**OSD defaults open (switch 1 at the “ON” position )**



### 11.3 TX5838(FCC)/TX5839(CE) Transmitter Channel Selection

8 transmission channels optional, channel with good image quality is selected in line with video reception.

Channels corresponding to code switch positions are as follows:

Channel	1	2	3	4	5	6	7	8
Freq. point	5866MHz(CE) 5847MHz(FCC)	5847MHz	5828MHz	5809MHz	5790MHz	5771MHz	5752MHz	5733MHz
Code switch position (on/off)								



Attention:

- One-to-one correspondence is between transmitter channel and video receiver channel.

### 11.4 DEVO-RX721 receiver introduction

How to remove fixed ID code:

After the receiver is set as fixed ID code by using remote controller (Refer to Remote Controller Instruction for more information about the “fixed ID” settings), please press the key Clean to clear ID code when necessary, switch on aircraft power, receiver’s red indicator light slowly flashing, which means that receiver’s fixed ID memory has been cleared, meanwhile remote controller’s “fixed ID” also needs to be closed.

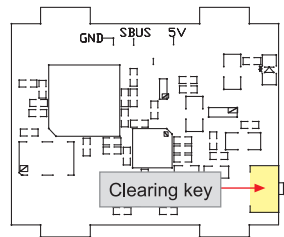

## 11.5 FCS-F215 flight controller introduction

### Port introduction

1. External PPM receiver port:  
External PPM receiver  
(it needs to run the Cleanflight software for tuning)
2. External SBUS receiver port: connect to SBUS receiver
3. BOOTO button(brush button):  
refer to the Cleanflight software for specific operation
4. Receiver toggle switch:  
Internal—factory settings  
External—external SBUS receiver  
(external PPM receiver is independent of switch position)
5. Connection port of flexible flat cable
6. USB upgrade port
7. SWD port

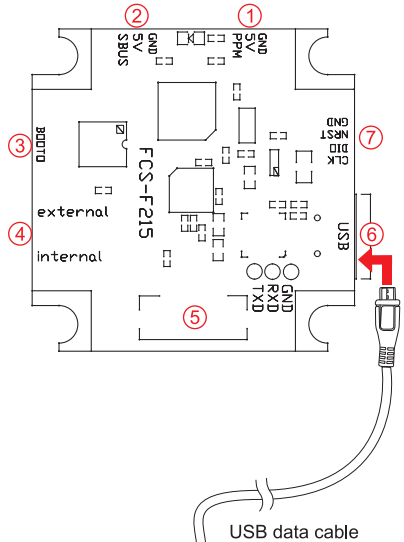

### Flight controller upgrade

Online upgrading is available from Walkera official website.

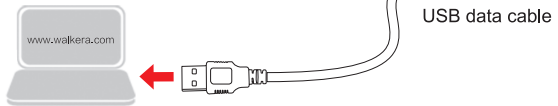

## 11.6 Connection diagram of brushless ESC & brushless motor

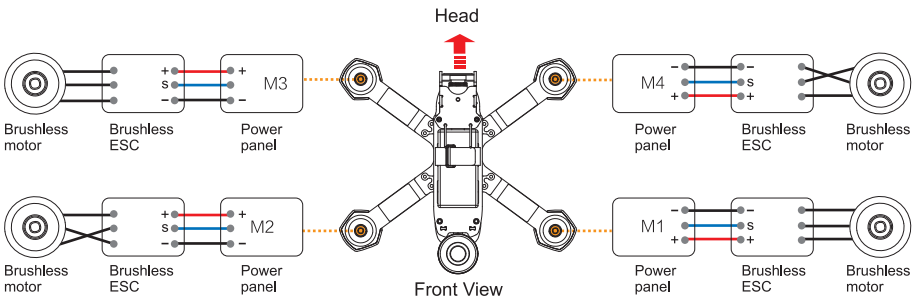



Manufacturer: Guangzhou Walkera Technology Co.,Ltd.

Add: No.48 Wantai Rd, Taishi Industrial Park,

Dongchong Town, Nansha Dist, Guangzhou, China.511453

Hotline: 400-931-8878

This manual is subject to update without prior written notice.  
Please refer to Walkera official website for latest version.

